



NRG70 DOOR

70mm PVCu Residential Door



OPTIONAL



Chamfered bead

OPTIONAL



Sculptured bead

Platinum[®]
NRG

www.platinumnrg.co.uk

NRG70 DOOR

Platinum[®]
NRG

HARDWARE OPTIONS



Two styles – modern (shown) or classic scrolled Lever/ Lever and Lever/ Pad combinations available. Aluminium and stainless steel construction.



STANDARD FINISHES

PlatinumNRG Chamfered

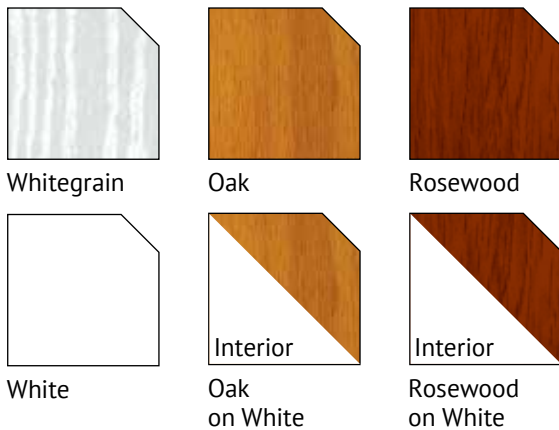

PlatinumNRG Sculptured

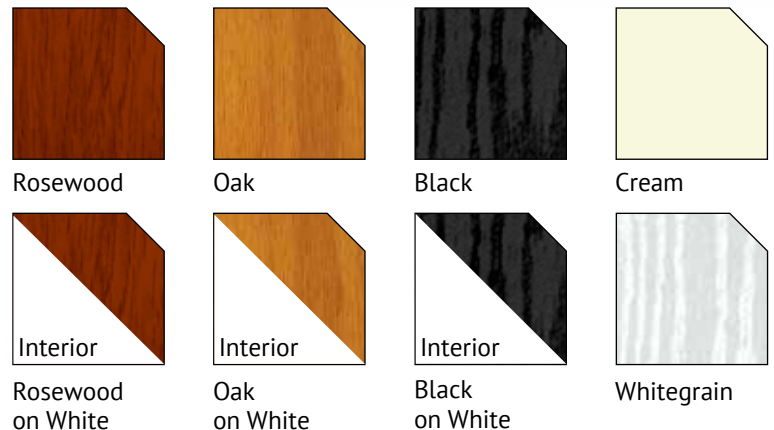

OPTIONAL FINISHES

A wide range of woodgrain and coloured-foil options are available for either or both internal and external faces or even differing frames and sashes.



www.platinumnrg.co.uk

NRG70 DOOR

HINGES



Designed for ease-of-use and a draft-free fit
Stainless steel stabilising pins for enhanced security.
Available in a choice of colours to match your door.

LOCKING SYSTEM



Special hook bolt for high level security.
Made from high quality, rust free, stainless steel for longer life performance.



Platinum[®]
NRG

NRG70 DOOR

THIS EXAMPLE SHOWS THE **CHAMFERED FRAME** IN AN **INWARD-OPENING CONFIGURATION**

100% LEAD FREE PVCu
Completely free of poisonous lead stabilisers.

GLOSS FINISH
Polished finish reduces cleaning and maintenance and retains a cleaner look for longer helping resist airborne pollutants and moulds.

DOUBLE-GLAZED UNIT available for entire door or by using additional transoms and mullions just for parts of the door.

OPTIONAL MID-RAIL or **INTERNAL TRANSOM**

SOLID REINFORCED PANELS available for entire door or by using additional transoms and mullions just for parts of the door.

Weather bar

LOW PVCu threshold

Stub cill

THRESHOLD OPTIONS

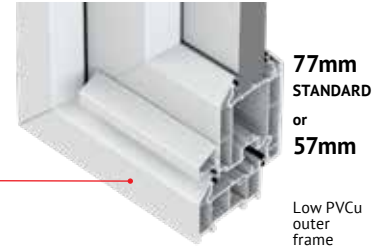

FRAME ONLY

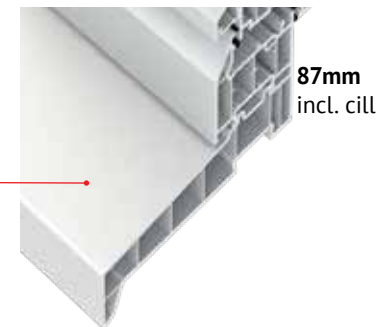

FRAME AND CILL

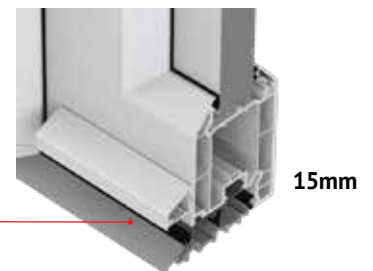

ALUMINIUM PART M COMPLIANT

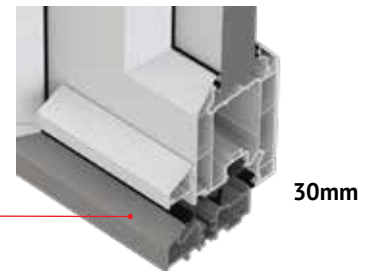

ALUMINIUM LOW THRESHOLD

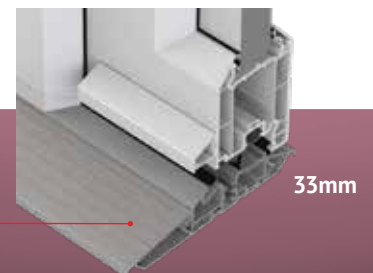

ALUMINIUM LOW THRESHOLD AND TRAY RAMP





NRG French DOOR

70mm PVCu French Door



STANDARD



Chamfered bead

OPTIONAL



Sculptured bead

**Platinum[®]**
NRG

www.platinumnrg.co.uk

NRG French DOOR

Platinum[®]
NRG

HARDWARE OPTIONS



Two styles – modern (above) or classic scrolled (right)

All our French Doors incorporate balanced (a matching pair of) handles as standard for a symmetrical appearance.

SCROLLED HANDLE



STANDARD FINISHES

Platinum NRG[®] CHAMFERED

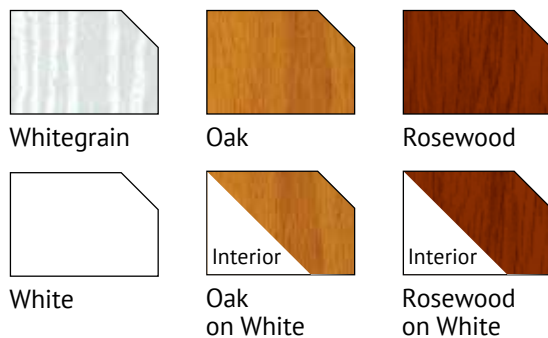

Platinum NRG[®] SCULPTURED

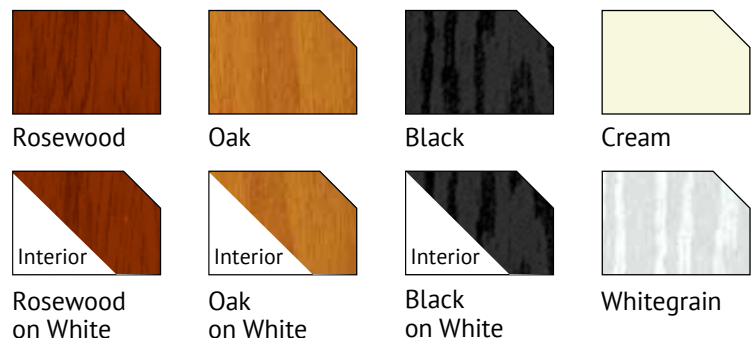

OPTIONAL FINISHES

A wide range of woodgrain and coloured-foil options are available for either or both internal and external faces or even differing frames and sashes.



NRG French DOOR

HINGES



HAVEN



SFS

Designed for ease-of-use and a draft-free fit. Stainless steel stabilising pins for enhanced security. Available in a choice of colours to match your door. Made from high quality, rust free, stainless steel for longer life performance.

LOCKS



2-hook, 2-roller system. Bi directional hooks with anti-jemmy feature. Brass forged to provide superior performance & weather sealing.



3* STAR
Upgraded ATK Cylinder
is **OPTIONAL**



1* STAR
Security Cylinder
is **STANDARD**

Our **1* STAR** cylinder resists bumping, drilling, picking and screw attacks. Keyed-alike only in pairs.

Our **3* STAR** cylinder resists all of the above with the addition of anti-snap protection. Multiple keyed-alike.

The logo for Platinum NRG, featuring a green leaf icon above the word 'Platinum' in a white serif font, and 'NRG' in a bold green sans-serif font below it.

NRG French DOOR

THIS EXAMPLE SHOWS THE **CHAMFERED FRAME** IN AN **INWARD-OPENING CONFIGURATION**

100% LEAD FREE PVCu
Completely free of poisonous lead stabilisers.

GLOSS FINISH
Polished finish reduces cleaning and maintenance and retains a cleaner look for longer helping resist airborne pollutants and moulds.

DOUBLE-GLAZED UNIT available for entire door or by using additional transoms and mullions just for parts of the door.

OPTIONAL MID-RAIL or **INTERNAL TRANSOM**

SOLID REINFORCED PANELS available for entire door or by using additional transoms and mullions just for parts of the door.

Weather bar

LOW PVCu threshold

Stub cill

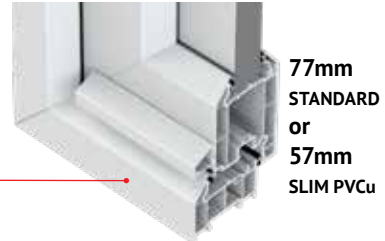

77mm
STANDARD
or
57mm
SLIM PVCu

FRAME ONLY - LOW THRESHOLD

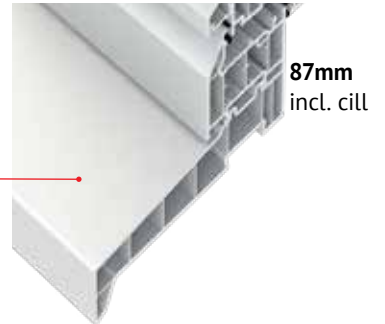

87mm
incl. cill

FRAME AND CILL

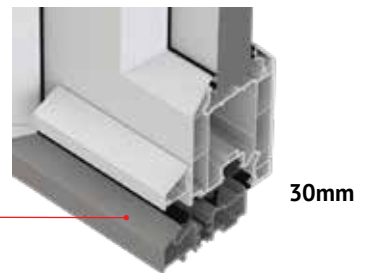

30mm

ALUMINIUM LOW THRESHOLD

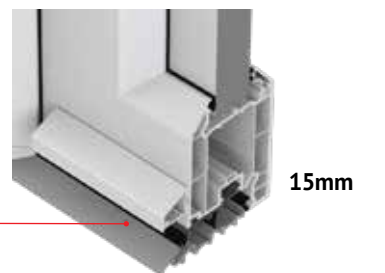

15mm

ALUMINIUM PART M COMPLIANT

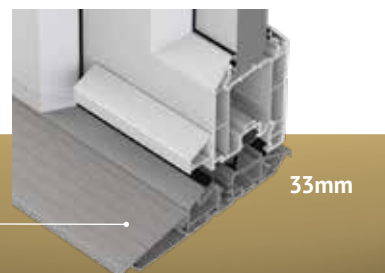

33mm

ALUMINIUM LOW THRESHOLD AND TRAY RAMP - ENHANCED PART M COMPLIANCE





built for
peace of mind

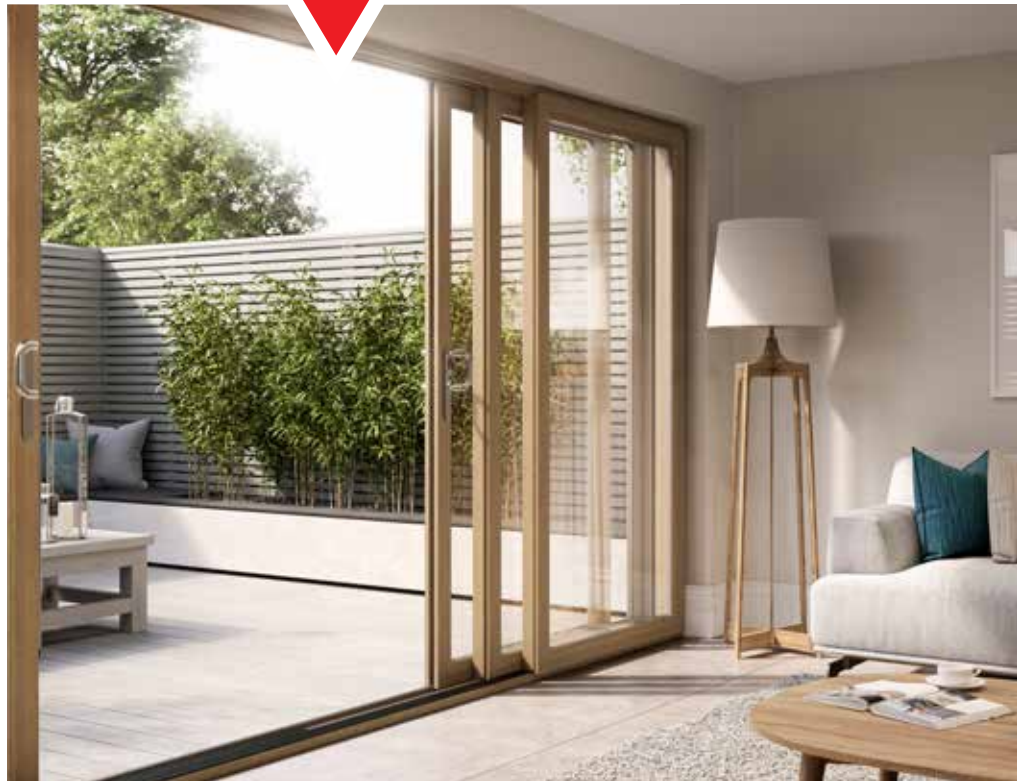

 **PatioMaster**[®]
IN-LINE SLIDING PATIO DOOR



Welcome to **warmth, security and peace of mind**

When you choose a PatioMaster sliding door, you're making a wise decision.

You're choosing style, but you're also deciding to have a warmer, brighter home that works for the way you want to live. You're opting for security, energy-efficiency and low maintenance. You're choosing guaranteed quality and ease of installation.

But that's not all: you're choosing the door that you want, built for

you, to your exact specification. Every PatioMaster door is fully bespoke, and each one has our attention to detail, our service and our support included as standard.

Choosing technically advanced, high-performing doors that look fantastic – that's a very wise decision.

Stylish and **perfectly engineered**

An introduction to PatioMaster sliding doors

Because every home is different, and every homeowner is an individual, one size doesn't fit all. That's why as well offering completely bespoke inline sliding doors, we also offer Triple Track doors. Here's how the two styles differ.





In-line Sliding Doors

These doors are the familiar patio door style, with two tracks. They come in 2 or 3-pane formats where one of the panes slides and the other(s) is (are) fixed or 4-pane formats where there are two fixed and two sliding panes. When opened the sliding pane sits alongside a fixed pane. The opening is always in the same position.

Triple Track Sliding Doors

As you'd expect from the name, Triple Track doors have three tracks. A 3-pane version would have two sliding panes and one fixed pane which means there's plenty of flexibility when you want to open them. Up to six panes can be 'stacked' in any position, giving an opening that's up to two-thirds of the total aperture – far wider than a conventional in-line sliding door.

Two styles, one approach

It doesn't matter which style you choose, whether your home is sleek and modern or a cosy rural retreat, all PatioMaster sliding doors fit perfectly.

It's because we've paid attention to detail, to getting the features right and to making them flexible. It's about allowing you to choose what you want. Your choice of frame style, finish and colour. Your choice of layout, handles and security features. If you want to match your existing glazing, that's fine. If you want something different, that's fine too.

Add personality to your room and create a structural focal point. Whatever your choice, you can be assured that the beauty you've picked is more than skin deep and is backed up by our brilliant engineering.



3 simple ways to a **better lifestyle**





Light

Light enhances our mood: quite simply, it makes us feel good. What better way than to let more natural daylight in, than with beautifully designed, floor to ceiling, sliding patio doors?

Creating a bright, airy space is easy with PatioMaster. The clean lines of our slim frames ensure that the glass area is maximised. You see more of the view and less of the door. If you've got a great garden or overlook fantastic scenery, make the best of it and fill your home with light.

Space

It's not always about how much space you have, but more about how you use it. If your dining room is too small for entertaining, open up onto the patio or decking area. If your garden's small, make the most of a balcony with space-saving sliding doors. If you've nowhere to work or study – build a garden office, bright and airy but still snug against the elements.

As our lifestyles change, our homes can change too. Divide internal spaces, open up old rooms, build new ones – be flexible, adapt and live better.

Air

With an easy-to-open sliding door, it's easy to get more fresh air. Open a tiny bit for extra ventilation, or open wide to get the air moving around your home. Stop living sealed away from nature – enjoy the fresh smell of recent rain and hear the birds sing.

A Triple Track door is simply brilliant for this. With so many ways to open up and the option of a really wide aperture, you'll feel refreshed and energised.

Perfectly designed for any home

Bespoke Service

There's nothing "off the shelf" about our sliding doors. Each one is built to order, to your exact measurements and to the design that you choose.

Our doors can be built to fit almost any space – the only restrictions are on sizes that would compromise your safety or the structural integrity of your home. With the In-line style, you can have 2, 3 or 4 panes and you choose which panes you want to slide. With Triple Track sliding doors, up to 6 panes are possible.

We have a range of colour choices for your frames and a range of handle styles and finishes. With sculptured or bevelled sashes, we can match your existing glazing, and with optional internal low thresholds, we can ensure improved access. You can even use sliding doors as front entrances with an optional midrail and letterplate.

Our doors are suitable for all types of homes from bungalows to high-rise. We've designed them for ease of installation, with slim stepped frames which minimise plaster cutback and help installers to protect your décor.

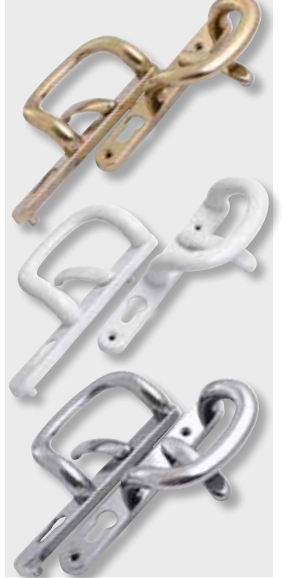



In-line Sliding Doors

Your patio door – built your way

There's a lot of flexibility with in-line sliding door layouts, which means the design works great in homes of all sizes. 2-pane styles have a minimum width of just under 1.6 metres, the largest 4-pane models can span an aperture almost 6 metres wide. In all cases, if you want extra light – even more glass – we can add fixed panes to the side, easily matching the appearance of the biggest bifolding doors.

These sliding doors aren't just brilliant for accessing the garden. Because they're so streamlined they make a great option for a porch or conservatory, sliding open without needing extra floor space. If you're using them for a front entrance, we've even got a midrail that's perfect for a letterplate or house number.

Every component in our sliding doors is of the highest quality. Tested and trusted by the trade and homeowners alike, these are sliding doors that are ranked amongst the most highly specified products in the marketplace.

Style	Max Width	Max Height	Min Width*	Min Height*
2 Pane	3004	2360	1574	1900
3 Pane (Centre Slider)	4509	2360	2364	1900
3 Pane (End Slider)	4425	2360	2380	1900
4 Pane	5928	2360	3068	1900

Minimum width and height:

The above sizes given are guideline dimension. These can be dependent upon building regulations and usual planning law. In special applications for sizes required less than these please refer to the technical department.



A guide to the features of PatioMaster's In-line sliding doors

- A Slim frame has stepped shape to make installation easier and protect your décor
- B Match existing window and door hardware with a choice of handle colour
- C Vast range of woodgrain and colour options as well as classic white
- D Low thresholds for internal purposes only*
- E High performing unobtrusive gaskets and seals
- F 28mm double glazing insulates your home
- G Multi-chambered sash for strength and thermal efficiency
- H Six-point locking system for outstanding security
- I Concealed fixings (no ugly screw heads)
- J Midrail option with letterplate for front entrances
- K Option of shaped sashes to complement sculptured windows.

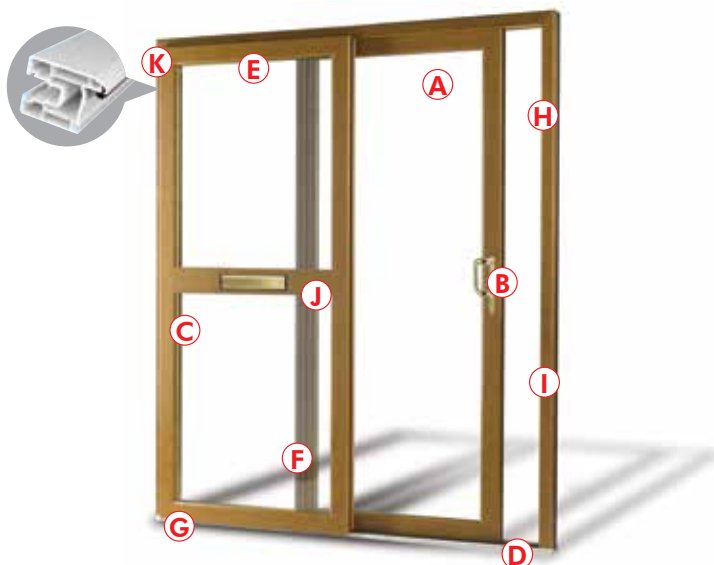

*Unsuitable for external facing applications







Triple Track doors

The real alternative to a bifolding door

PatioMaster's Triple Track doors give you the open-house look and feel, but in a format that's much more practical than a bifolding door. Triple Track is neater and more streamlined. Why fuss and fold when you can stack? Even on small-sized installations, there's a wide clear opening, and you can get superb results for apertures up to 6-metres wide.

Because Triple Track is designed to complement PVC-U windows and doors, it's fully compatible with ancillary products so that every job can have an immaculate finish, and because we know how important it is for you to feel safe and secure, there's a high-security 6-point locking system.

"The effortless, wide-opening, affordable, insulating, durable, secure, easy to install and good-looking sliding door."

We've called it Triple Track for short.

Style	Max Width	Max Height	Min Width*	Min Height*
3 Pane (3 Track End Slider)	4424	2360	2279	1900
3 Pane (End Track Centre Slider)	5928	2360	4479	1900

Minimum width and height:

The above sizes given are guideline dimension. These can be dependent upon building regulations and usual planning law. In special applications for sizes required less than these please refer to the technical department.



Why choose a Triple Track?

Floor-to-ceiling glass has a wow factor that's undeniable and has rapidly become something that everyone can aspire to. There has been a great deal of interest in bifolding doors but some of those who have rushed to install them are noticing that – for all their promises – bifolding doors aren't always the best option.

PatioMaster has long been at the forefront of sliding door technology, so perhaps it shouldn't be a surprise that we've developed a new type of sliding door which offers the full floor-to-ceiling glass aesthetics alongside easy operation and a space-saving layout.





The benefits of Triple Track

- Each sliding pane stacks neatly behind the fixed pane when the door is opened. A full two-thirds of the aperture can be open, and even for smaller frame sizes, they deliver the open-house feel.
- Triple Track doors are easy to open. Built using stainless-steel tracks and edge-located rollers, the panes simply glide along without the worry of moving furnishings or securing a stack of folded panes.
- Without the complex mechanisms, a Triple Track door is reliable. With fewer moving parts than a bifold, there is less chance of problems, either during installation or afterwards. Backed up by top quality components, the PVC-U and rigid aluminium composite materials are robust and durable.
- Triple Track is a superb match for PVC-U windows and doors. You can have the same shapes, colours and finishes. There's a choice of chamfered and ovolo details and 28 different foiled finishes for complete consistency across your home.
- Triple Track insulates and protects your home from the elements. You'll feel warm and cosy with 28mm double glazing, and if you're a fan of numbers as well as comfort, you'll be reassured by U-values as low as 1.4 W/m²K.

Glass

We'd never dream of treating the glass in your sliding doors as an afterthought. It's an integral part of the whole. The choice of glass affects not just the appearance of your home, but also your comfort and your energy usage.

Modern surface coatings, which are practically invisible, can control the amount of solar gain and heat loss. Double or triple-glazed units are filled with inert gases, constructed using warm-edge spacers and with differing glazing gaps to insulate your home in the most appropriate way for its location and your needs.

As every home is different, it wouldn't be right for us to give rigid performance figures in this guide, but we'll work with you to find the best combination for your home and the way you use it.





18



Benefits of sliding patio doors

1 **Patio doors improve your home's energy efficiency**

PatioMaster doors are designed to insulate, but they also allow more natural light into your home and give you more options for ventilation. You could find yourself making savings on heating, lighting and air conditioning.

2 **Patio doors look great**

Patio doors have clean, uncluttered styling that looks at home almost anywhere. Your furnishings and décor have the perfect neutral backdrop of a door that doesn't need to shout to be effective and that doesn't detract from the view.

3 **Patio doors connect you to the outside**

Because the glass extends to floor level you'll get much better views of the world outside. Even on the chilliest days, you'll be able to enjoy your garden. When it's warm, open up in seconds for a home that flows indoors and out.

4 **Patio doors make access easy**

Our sliding doors glide along their tracks so easily that opening them will never feel like a chore. It's almost effortless, but there's another advantage to a wide opening door. If you've ever struggled to shift a bulky piece of furniture through a normal doorway, you'll know what we mean – that extra width can be a godsend.

5 **Patio doors are streamlined**

You can hang curtains and have furnishings right next to a sliding door and you won't need to move them when you want to open up. Bifolding or French doors need more space because their panes to swing in or out.

Even our handles have **strength and style**

There are no corners cut, no detail left out. We've looked at every aspect of our inline patio doors design, every angle, every joint and every groove. Hardware is perfect, colours appropriate, proportions exactly right.

Everything matters, every little thing. Which is why we've chosen outstanding handles. Secure and robust, they are available in White, Hardex Satin, Anthracite Grey, Hardex Bronze, Hardex Gold, Hardex Chrome, Hardex Graphite, and Antique Black.









Smooth, quiet, **robust and secure**

Even though our doors are solidly built, you won't find them hard work. We've put the effort into the engineering so, for you, it'll be a breeze. All our sliding doors are lightweight in operation, gliding smoothly and quietly on their tracks. And because our doors are so easy to open and close you'll find yourself popping outside more and more.

The secret is in the design. Our easyglide technology makes opening and closing PatioMaster doors a matter of child's play.

Both our In-line and Triple Track doors are designed for durability. The good looks don't fade, they last year after year. Our doors won't split, crack or warp, and they'll stand up to the worst of the weather without complaining. And PVC-U is remarkably strong and impact resistant, so the kids can still play football! You don't need to paint or use wood preservatives so there are no solvents or nasty chemicals involved and maintenance is as easy as a quick wipe with a soapy cloth.

We guarantee our doors for ten years, but we expect that you will go on enjoying them much longer than that. They are made to be easy to care for so that you have more time to get on with the important things in life.



Insulating patio doors that **won't cost the earth**

We all want an energy efficient home. We want to keep the warmth in and the cold out. PatioMaster doors are designed to do just that.

- Weather-seals that prevent drafts and leaks
- Thermally efficient PVC-U frames for reduced heat transmission
- 28mm double glazing as standard
- Upgrades to low emissivity glass
- Insulation from external noise

Our doors are good for the planet in other ways too. Forget what you might think about PVC-U, it's a surprisingly "green" building material because it's so long lasting and because it's recyclable up to ten times.

Our doors are made from lead-free materials, and because there's no painting to worry about there's no need to use noxious chemicals to keep them looking good.

All in all, these great insulated doors are a fantastic choice for the environment, inside and outside your home.





Protecting your home, protecting you

Because your home is your castle, we've developed a range of doors that are engineered to be strong, safe and secure. To be frank, the very earliest patio doors weren't designed with security in mind. But when PatioMaster got involved, we made sure our sliding doors would stand out for the right reasons.

PatioMaster doors are steel reinforced, secured with multipoint locks and have anti-jacking technology. With internal sliding panels, 28mm glazing and extra reinforcing around the locks our doors are, simply, more resistant to attack from intruders.

Designed for easy maintenance and long life, our locking systems are designed to keep you, your family, your possessions and your home safe and sound for years to come.

Protection from the elements

The British weather can do a lot of damage to a property that doesn't have the right protection. That's why we've taken every precaution to ensure cold and rain can't get into your home. A combination of high-quality double glazing, bonded gaskets and weather-seals, and a thermally efficient three chamber system means that every patio door we make does its job.

Standard Specification - **Features**

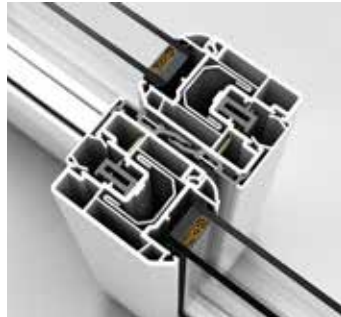

- Key enhancement is the concealed security interlock (dogbolt)
- Improved anti-lift performance with reduced sash movement: 6 hook locking replaced with 6 POINT locking (4 hooks + 2 anti lift pins)
- Anti-lift pin also improves lock location into keeps.



PAS24 Specification - **Features**



- 6 hook locking + 2 plunge bolts replaced with 12 POINT locking (8 bi directional hooks, located equally including top and bottom corners + 4 anti lift pins + concealed security interlock (dogbolt)
 - Meets requirements of Doc M
 - Improved aesthetics (removes need for unsightly plunge bolts)
 - Speedier fabrication time due to elimination of plunge bolt prepping
- ERA Total Security Guarantee – patio door replaced if broken into and a £5k cheque to the homeowner (scheme operated and administered by ERA).

Total Security Guarantee

If you suffer a break-in due to security hardware failure,
ERA guarantee:

- A replacement door
- £5,000 compensation
- Valid for the lifetime of your doors



The only guarantee
scheme recognised by the Neighbourhood Watch





Guaranteed, **tested** and **proven**

With a warranty that covers you for ten years, you can rest easy. We've done the work, specifying the best possible components to bring you the ultimate sliding patio doors

- Our PVC-U profiles are made in the UK and conform to BS EN 12608
- PVC-U is fire resistant to BS 476, Part 7 (Class one)
- Our lock system is tested to 103,000 cycles and complies with BS 7412
- Rollers are tested to 150,000 cycles
- Doors are reinforced with hot-dipped galvanised mild steel
- Trickle ventilation compliant with Part F of Building Regulations
- Access compatible with Part L of Building Regulations
- Fully compliant with CE Marking Regulations.



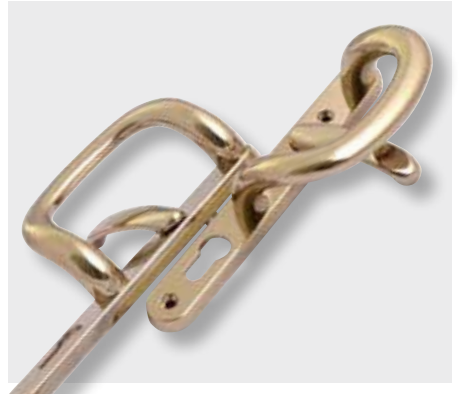

Colours

It's your home, so it's your choice. Classic White or Anthracite Grey are perfect for simple understated elegance. Bold colours are ideal for when you want to make a statement or for showing your sense of style. If you want, you can select a different finish for indoors and out.

PatioMaster sliding doors are available in an incredible choice of 30 foiled finishes, including wood effects, solid colours and flat and grained textures. We use the best quality foils, permanently bonded to our profiles and which won't peel, flake or fade, giving you good looks that last.

Stock Colours

Premium



Rosewood / Rosewood (Brown Base) Rosewood / White (PVC-U) (White Base) Light Oak / Light Oak (Tan Base) Light Oak / White (PVC-U) (White Base)



Black Brown / Black Brown (Brown Base) Black Brown / White (PVC-U) (White Base) Anthracite Grey / Anthracite Grey (Grey Base) Anthracite Grey / White (PVC-U) (White Base)

Premium Plus



Cream / Cream (Cream Base) Cream / White (PVC-U) (White Base) White / White (White Base)

Fast Track Colours

Premium



Anthracite Grey Smooth / Anthracite Grey Smooth (Grey Base) Anthracite Grey Smooth / White (PVC-U) (White Base)

Premium Plus



Pebble Grey / White (PVC-U) (White Base) Sage Smooth / White (PVC-U) (White Base) Claystone / White (PVC-U) (White Base)

FoilExpress



White* Cream* Claystone* Windsor Agate Grey



Pebble Grey* Sage Smooth* Chartwell Green Dark Green Steel Blue



Dark Red Hazy Grey Finesse Kensington Grey Buckingham Grey Basalt Grey Smooth



Slate Grey Finesse Slate Grey Anthracite Grey Smooth Anthracite Grey Black Ultra-Matt*



Black Brown AnTeak* Irish Oak* Honey Oak Super-Matt* Light Oak



Rosewood Swamp Oak* Silver D Smooth* Pyrite* Flemish Gold Smooth*

Available on a white base. For non-white base please check for availability.

***Premium Plus**

It's because **we specialise**

For over twelve years PatioMaster has been specialising in sliding patio doors. It's all we do, which is why we do it so well. We've chosen the best in design, in materials and in manufacturing. And we've chosen a network of experts to build our doors, to your exact specification and to our exacting standards. Our approach is about continuous improvement. Better engineering, better designs, better service, more choice, more security and more support.

We like to think of ourselves as experts, and we are, but it's more than that: we're dependable too. We work through a small network of accredited fabricators throughout the UK and Ireland. You get the best of local service and area-specific knowledge; we know that the teams who represent us are second to none. We offer a quick turnaround on orders and free technical support to see you through the installation process and beyond.

We'll be there when you need us. With us, it's a matter of pride. Pride in our product, our service and in our support, so that you can be proud of your home.

**MADE IN
BRITAIN** 



An **outstanding door**,
an expert team and
superb support



www.patiomaster.co.uk

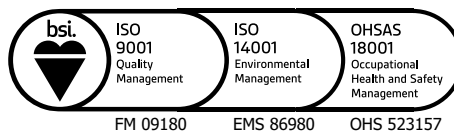

'PatioMaster' is a trading name of Specialist Building Products Limited. PatioMaster cannot be held accountable for manufacture or installation by independent companies. All information in this publication is provided for guidance only and is given in good faith. As it is company policy to continually improve products, methods and materials, changes of specification may be made from time to time without prior notice. This statement does not affect your statutory rights. © PatioMaster